

WIA

Light Industrial Welding Range

2023



WELD WITH THE BEST.

WELDING.COM.AU



WIA

NEXT GENERATION WELDERS

**New Look.
New Technology.
New Standard of
Performance.**

More robust, up to date technology and a fresh new look –
The new WIA equipment range has had more than a just face lift.

From the exterior design to individual machine components,
everything has been carefully developed to ensure each machine
delivers on usability, reliability and performance.

With 3 years warranty on all products and an Australia-wide service
network, the new WIA range offers better than ever reliability and
the best back-up service around.



CONTENTS

EQUIPMENT 6

Multi-Process	10
Arc & TIG	14
MIG	18
Plasma Cutters	22

FILLER METALS 24

Electrodes	26
MIG Wires	28

WELDING SAFETY 30

Welding Helmets	32
-----------------	----

WELDING MACHINES

No matter your industry we have you covered.

From maintenance, rural, construction to medium and heavy fabrication applications.



CHOOSE THE RIGHT WIA WELDING MACHINE FOR YOU.

Here's a few things to consider to help you make the right choice.



1. Process

From MIG, Stick, DC TIG, AC TIG, Plasma Cutting and more – select a machine that is capable of the process you'll need it for.

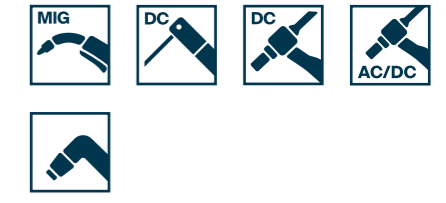

2. Plug

10 Amp, 15 Amp, 25 Amp, 32 Amp, single phase (240 V) or 3 phase (415 V) – make sure the machine suits the power supply you'll have access to.

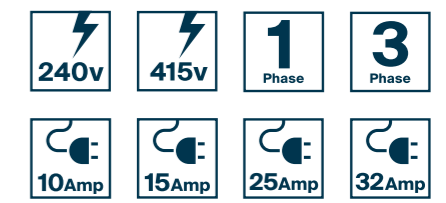

3. Material

Steel, stainless steel to aluminium – check the machine is suitable for the material you're working with.

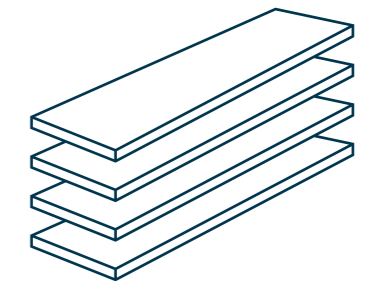

4. Metal Thickness

Thin gauge, 6, 8, 10, 12mm or 12mm plus – choose a machine that is suitable for the metal thickness you're working with.

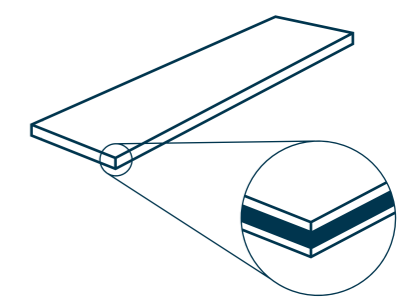



MULTI-PROCESS

Inverter welders

MIG, Stick or TIG weld with ease, with one single machine.

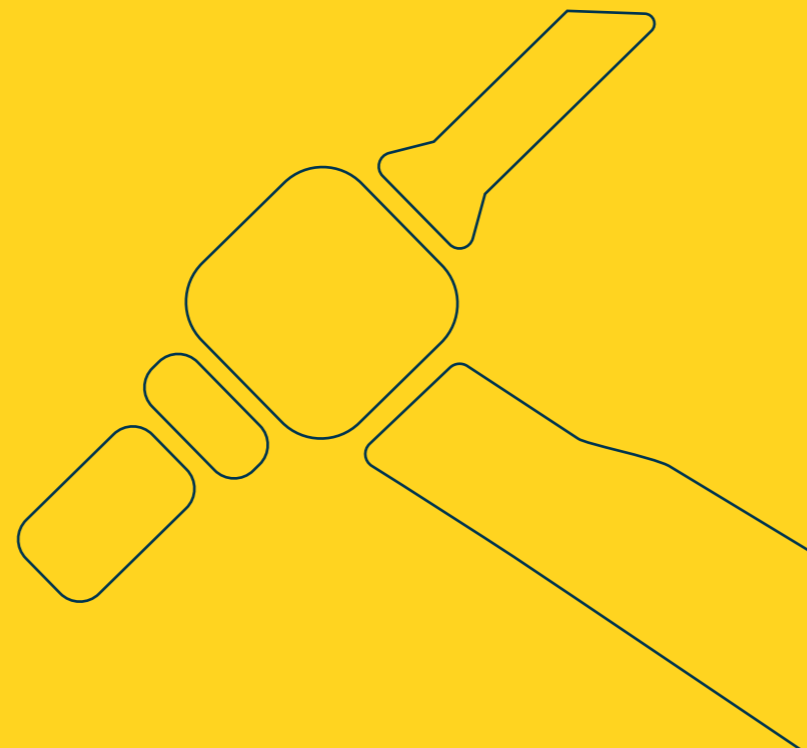

SPECIFICATIONS

	WELDMATIC 180	WELDMATIC 200	WELDMATIC 200+	WELDMATIC 250	WELDMATIC 350	WELDMATIC 500
INPUT POWER	240 V Single Phase	240 V Single Phase	240 V Single Phase	240 V Single Phase	415 V Three Phase	415 V Three Phase
RATED PRIMARY CURRENT	10 Amps	14 Amps	13.4 Amps	19.2 Amps	20 Amps	32 Amps
OUTPUT	180 A at 23 V, 10% Duty Cycle 57 A at 16.9 V, 100% Duty Cycle	200 A at 24 V, 15% Duty Cycle 77 A at 17.9 V, 100% Duty Cycle	200 A at 24 V, 15% Duty Cycle 77 A at 17.9 V, 100% Duty Cycle	250 A at 26.5 V, 20% Duty Cycle 112 A at 19.6 V, 100% Duty Cycle	350 A at 31.5 V, 60% Duty Cycle 271 A at 27.6 V, 100% Duty Cycle	500 A at 39 V, 60% Duty Cycle 387 A at 33.4 V, 100% Duty Cycle
THICKNESS						
THIN GAUGE	✓	✓	✓	✓	✓	✓
6MM	✓	✓	✓	✓	✓	✓
8MM		✓	✓	✓	✓	✓
10MM				✓	✓	✓
12MM					✓	✓
MULTI-PASS 12MM PLUS					✓	✓
MATERIALS TO BE WELDED						
STEEL	✓	✓	✓	✓	✓	✓
STAINLESS STEEL	✓	✓	✓	✓	✓	✓
ALUMINIUM	✓	✓	✓	✓	✓	✓
APPLICATIONS						
	Light Fabrication Repair and Maintenance Automotive Farming Building and Construction	Light to Medium Fabrication Repair and Maintenance Automotive Farming Building and Construction	Light to Medium Fabrication Repair and Maintenance Automotive Farming Building and Construction	Light to Medium Fabrication Repair and Maintenance Automotive Farming Building and Construction	Medium to Heavy Fabrication	Medium to Heavy Fabrication
PROCESSES						
BEST FOR	MIG Gas-Shielded, MIG Gasless	MIG Gas-Shielded, MIG Gasless	MIG Gas-Shielded, MIG Gasless	MIG Gas-Shielded, MIG Gasless	MIG Gas-Shielded, MIG Gasless	MIG Gas-Shielded, MIG Gasless
ALSO SUITABLE FOR	DC Stick, DC TIG	DC Stick, DC TIG	DC Stick, DC TIG	DC Stick, DC TIG	DC Stick, DC TIG	DC Stick, DC TIG



WELDMATIC 180

P/N: CP141-1

Portable and easy to power with a 10A plug. Outstanding welding performance.

- Beginner
- Intermediate

- Light Fabrication
- Repair and Maintenance
- Automotive
- Farming
- Building and Construction



- 180 A single phase MIG, Stick & TIG welder
- 180 A at 23 V 10% Duty Cycle
- IP23S safety rating
- Portable - Only 11kg
- Integrated wire feeder - Suits 1kg and 5kg spools
- Welds up to 6mm steel, stainless steel or aluminium
- Suits gas-shielded and gasless flux-cored wires
- VRD (Voltage Reduction Device)
- Generator compatible - 10 kVa Peak



WELDMATIC 200

P/N: CP150-1

A portable and compact welder with digital meters for an easy set up.

- Intermediate
- Professional

- Light to Medium Fabrication
- Repair and Maintenance
- Automotive
- Farming
- Building and Construction



- 200 A single phase MIG, Stick & TIG welder
- 200 A at 24 V 15% Duty Cycle
- IP21S safety rating
- Portable - Only 15kg
- Integrated wire feeder - Suits 1kg and 5kg spools
- Welds up to 8mm steel, stainless steel or aluminium
- Suits gas-shielded and gasless flux-cored wires
- VRD
- Generator compatible - 12 kVa Peak



WELDMATIC 200+

P/N: CP142-1

A portable and compact welder featuring a new LCD digital interface with pre-set modes for easy set up.

- Intermediate
- Professional

- Light to Medium Fabrication
- Repair and Maintenance
- Automotive
- Farming
- Building and Construction



- 200 A single phase MIG, Stick & TIG welder
- 200 A at 24 V 15% Duty Cycle
- IP23S safety rating
- Portable - Only 17kg
- Integrated wire feeder - Suits 1kg and 5kg spools
- Welds up to 8mm steel, stainless steel or aluminium
- Suits gas-shielded and gasless flux-cored wires
- VRD
- Generator compatible - 8.3 kVa Peak



WELDMATIC 250

P/N: CP143-1

Features a new LCD digital interface plus a built-in wire feeder with 15kg spool capacity for greater flexibility.

- Intermediate
- Professional

- Light to Medium Fabrication
- Repair and Maintenance
- Automotive
- Farming
- Building and Construction



- 250 A single phase MIG, Stick & TIG welder
- 250 A at 26.5 V 20% Duty Cycle
- IP21S safety rating
- 37kg. Comes with 2 handles for a two person lift.
- Integrated wire feeder - Suits 5kg and 15kg spools
- Welds up to 10mm steel, stainless steel or aluminium
- Suits gas-shielded and gasless flux-cored wires
- VRD
- Generator compatible - 14 kVa Peak



WELDMATIC 350

P/N: CP144-1

Packed with Power. A complete welding package for industrial applications.

- Professional

- Medium to Heavy Fabrication



- 350 A three phase MIG, Stick & TIG welder
- 350 A at 31.5 V 60% Duty Cycle
- IP21S safety rating
- 97kg (power source, wire feeder and accessories)
- Packaged with a 4 roll drive wire feeder, 10m interconnecting lead kit and trolley with drawer
- Welds 12mm+ steel, stainless steel or aluminium
- Suits 5kg and 15kg spools
- Suits gas-shielded and gasless flux-cored wires
- VRD
- Generator compatible - 25 kVA Peak



WELDMATIC 500

P/N: CP145-1

The most powerful WIA package. Best for industrial fabrication.

- Professional

- Medium to Heavy Fabrication



- 500 A three phase MIG, Stick & TIG welder
- 500 A at 39 V 60% Duty Cycle
- IP21S safety rating
- 105kg (power source, wire feeder and accessories)
- Packaged with a 4 roll drive wire feeder, 10m interconnecting lead kit and trolley with drawer
- Welds 12mm+ steel, stainless steel or aluminium
- Suits 5kg and 15kg spools
- Suits gas-shielded and gasless flux-cored wires
- VRD
- Generator compatible - 35 kVA Peak

3 YEAR WARRANTY PAIR IT WITH Austfil T-11 WIA OpticFX helmet

3 YEAR WARRANTY PAIR IT WITH Austfil T-11 WIA OpticFX helmet

3 YEAR WARRANTY PAIR IT WITH Austfil T-11 WIA OpticFX helmet

3 YEAR WARRANTY PAIR IT WITH Austfil Excel WIA trolley with drawer

3 YEAR WARRANTY PAIR IT WITH Austmig ES6 WIA OpticFX Helmet

3 YEAR WARRANTY PAIR IT WITH Austmig 5356 WIA OpticFX Helmet

*For full rated output, a 20 A plug & supply is required with a 25 A circuit breaker.



STICK & TIG

Inverter welders

Flexible, reliable and portable welders that provide results that are hard to beat.

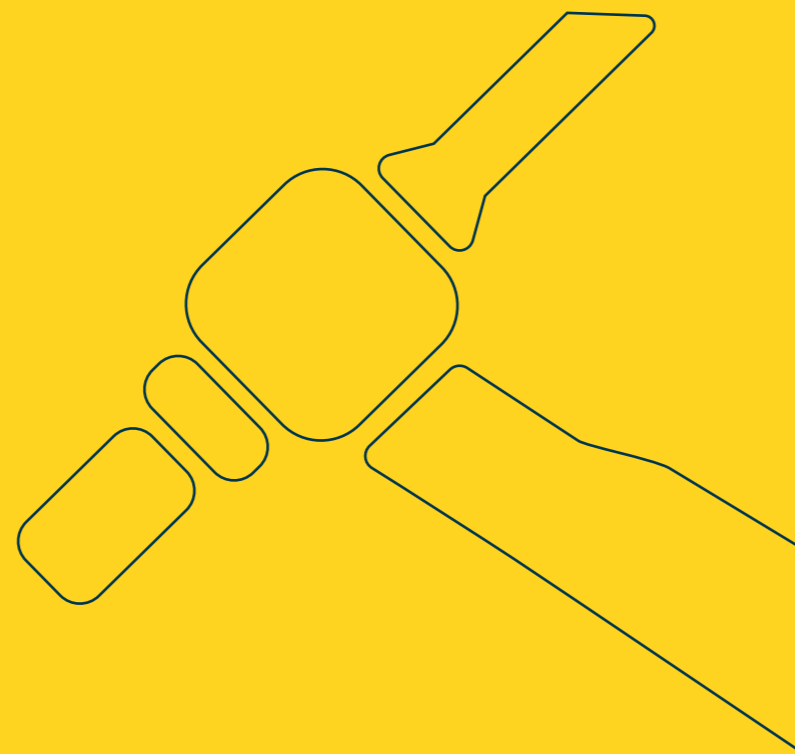

SPECIFICATIONS

	WELDARC 135	WELDARC 145	WELDARC 185	WELDARC 200 DC	WELDARC 200 AC/DC
INPUT POWER	240 V Single Phase	240 V Single Phase	240 V Single Phase	240 V Single Phase	240 V Single Phase
RATED PRIMARY CURRENT	9.9 Amps	8.5 Amps	12.5 Amps	14 Amps	12 Amps
OUTPUT	135 A at 25.4 V, 20% Duty Cycle 60 A at 22.4 V, 100% Duty Cycle	145 A at 25.8 V, 20% Duty Cycle 56 A at 22.2 V, 100% Duty Cycle	185 A at 27.4 V, 25% Duty Cycle 92 A at 23.7 V, 100% Duty Cycle	200 A at 18 V, 30% Duty Cycle 110 A at 14.4 V, 100% Duty Cycle	200 A at 18 V, 30% Duty Cycle 110 A at 14.4 V, 100% Duty Cycle
THICKNESS					
THIN GAUGE	✓	✓	✓	✓	✓ AC/DC TIG
6MM	✓	✓	✓	✓	✓ AC/DC TIG
8MM		✓	✓	✓	✓ AC/DC TIG
10MM			✓	✓	✓ DC TIG
MATERIALS TO BE WELDED					
STEEL	✓	✓	✓	✓	✓
STAINLESS STEEL	✓	✓	✓	✓	✓
ALUMINIUM					✓
CAST IRON	✓	✓	✓		
COPPER					✓
COPPER ALLOYS					✓
TITANIUM AND MAGNESIUM ALLOYS					✓
APPLICATIONS					
	Repair and Maintenance Farming DIY Projects	Light Fabrication Repair and Maintenance Farming Building and Construction	Light Fabrication Repair and Maintenance Farming Building and Construction	Repair and Maintenance Stainless Steel Fabrication Motor Sport Fabrication Food and Wine	Repair and Maintenance Aluminium Boat Fabrication Motor Sport Fabrication
PROCESSES					
BEST FOR	DC Stick	DC Stick	DC Stick	DC TIG	AC TIG
ALSO SUITABLE FOR		DC TIG	DC TIG	DC Stick	DC TIG, DC Stick



WELDARC[®] 135

P/N: MC110-0

Transportable, easy to use and welds with ease. Perfect if you're just starting out.

● Beginner

Repair and Maintenance
Farming DIY Projects



- 135 A single phase Stick welder
- 135 A at 25.4 V 20% Duty cycle
- IP21S safety rating
- In-built Arc Force
- In-built Hot Start
- Portable - Only 4kg (comes with a shoulder strap)
- Suits 2.0 - 3.2mm electrodes
- VRD
- Generator compatible: 7 kVa Peak



WELDARC[®] 145

P/N: MC111-0

Easy to pick up and pack up. It goes where you go.

● Beginner ● Intermediate

Light Fabrication
Repair and Maintenance
Farming Building and Construction



- 145 A single phase Stick & TIG welder
- 145 A at 25.8 V 20% Duty Cycle
- IP23S safety rating
- Adjustable Arc Force
- Adjustable Hot Start
- Portable - Only 7kg (comes with a shoulder strap and carry case)
- DC Lift Arc TIG Start
- Digital meters
- Power Factor Correction
- Suits 2.0 - 3.2mm electrodes
- VRD
- Generator compatible: 4.6 kVa Peak



WELDARC[®] 185

P/N: MC112-0

Lightweight yet robust, the 185 can easily be transported from the workshop to on-site.

● Intermediate

Light Fabrication
Repair and Maintenance
Farming Building and Construction



- 185 A single phase Stick & TIG welder
- 185 A at 27.4 V 25% Duty Cycle
- IP23S safety rating
- Adjustable Arc Force
- Adjustable Hot Start
- Portable - Only 8kg (comes with a shoulder strap and carry case)
- DC Lift Arc TIG Start
- Digital meters
- Power Factor Correction
- Suits 2.0 - 4.0mm electrodes
- VRD
- Generator compatible: 6 kVa Peak



WELDARC[®] 200DC

P/N: MC113-0

For precision DC TIG welding of steel, copper and titanium.

● Intermediate ● Professional

Repair and Maintenance
Stainless Steel Fabrication
Motor Sport Fabrication
Food and Wine



- 200 A single phase Stick & TIG welder
- 200 A at 18 V 30% Duty Cycle
- IP23S safety rating
- Portable - Only 12kg
- Welds up to 8mm steel
- Packaged with an 8m TIG torch
- HF Start
- Adjustable pulse mode
- Power Factor Correction
- VRD
- Generator compatible: 6 kVa Peak



WELDARC[®] 200AC/DC

P/N: MC114-0

AC TIG weld aluminium with ease. Features new LCD interface technology.

● Intermediate ● Professional

Repair and Maintenance
Aluminium Boat Fabrication
Motor Sport Fabrication



- 200 A single phase Stick & TIG welder
- 200 A at 18 V 30% Duty Cycle
- IP21S safety rating
- Portable - Only 17kg
- AC TIG for aluminium
- Welds up to 8mm aluminium or steel
- Packaged with an 8m TIG torch
- HF Start
- Adjustable pulse mode
- Power Factor Correction
- VRD
- Generator compatible: 5 kVa Peak

3YEAR WARRANTY PAIR IT WITH Austarc 12P Electrodes WIA OpticFX Helmet

3YEAR WARRANTY PAIR IT WITH Austarc 12P Electrodes WIA OpticFX Helmet

3YEAR WARRANTY PAIR IT WITH Austarc 16TC Electrodes WIA OpticFX Helmet

3YEAR WARRANTY PAIR IT WITH Foot control WIA OpticFX Helmet

3YEAR WARRANTY PAIR IT WITH Foot control WIA OpticFX Helmet



MIG

Transformer welding machines

Big on power and designed to last, WIA's MIG machines offer the ultimate MIG welding performance.

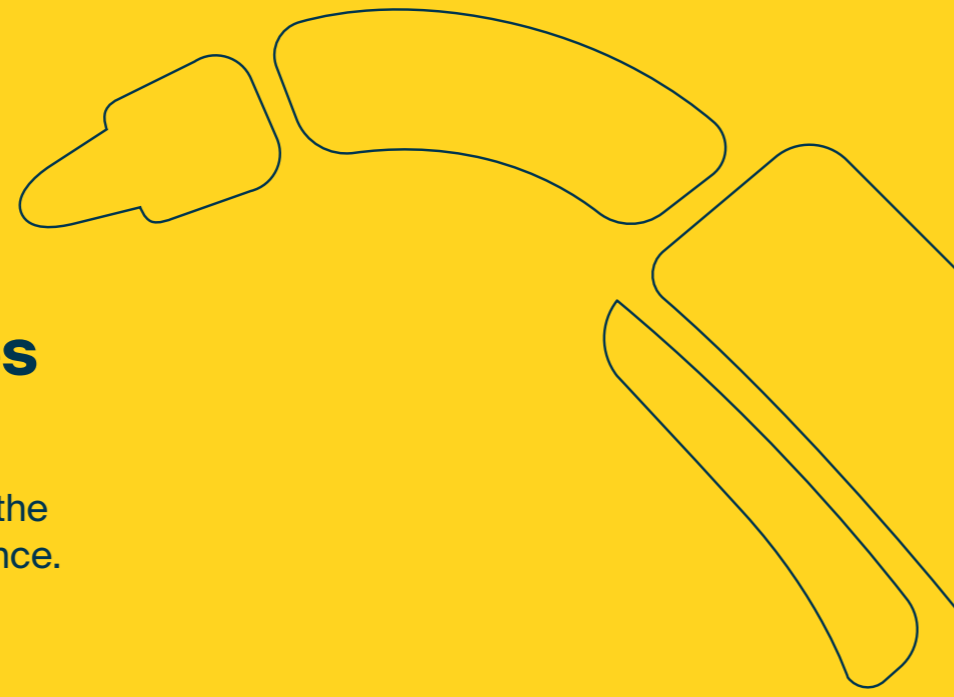

SPECIFICATIONS

	WELDMATIC 270	WELDMATIC 356	WELDMATIC 396	WELDMATIC FABRICATOR
INPUT POWER	240 V Single Phase	415 V Three Phase	415 V Three Phase	415 V Three Phase
RATED PRIMARY CURRENT	25.3 Amps	15 Amps	15 Amps	18 Amps
OUTPUT	270 A at 27.5 V, 20% Duty Cycle 120 A at 20 V, 100% Duty Cycle	355 A at 31.8 V, 40% Duty Cycle 225 A at 25.3 V, 100% Duty Cycle	395 A at 33.8 V, 40% Duty Cycle 220 A at 25 V, 100% Duty Cycle	400 A at 34 V, 45% Duty Cycle 270 A at 27.5 V, 100% Duty Cycle
THICKNESS				
THIN GAUGE	✓	✓	✓	✓
6MM	✓	✓	✓	✓
8MM	✓	✓	✓	✓
10MM		✓	✓	✓
12MM		✓	✓	✓
MULTI-PASS 12MM PLUS		✓	✓	✓
MATERIALS TO BE WELDED				
STEEL	✓	✓	✓	✓
STAINLESS STEEL	✓	✓	✓	✓
ALUMINIUM	✓	✓	✓	✓
APPLICATIONS				
	Rural Workshops Light to Medium Fabrication Body Shops and Maintenance	Workshops Medium to Heavy Fabrication	Workshops Medium to Heavy Fabrication	Workshops Medium to Heavy Fabrication
PROCESSES				
	MIG Gas-Shielded, MIG Gasless	MIG Gas-Shielded, MIG Gasless	MIG Gas-Shielded, MIG Gasless	MIG Gas-Shielded, MIG Gasless



WELDMATIC® 270

P/N: CP146-1

A single phase MIG package that's big on power!

● Intermediate ● Professional

Rural Workshops Light to Medium Fabrication

Body Shops and Maintenance



- 270 A single phase MIG welder
- 270 A at 27.5 V, 20% Duty Cycle
- IP21S safety rating
- Packaged with a W64-1 4 roll drive wire feeder and 10m interconnecting lead kit
- 115kg (power source, wire feeder and accessories)
- Welds up to 10mm steel/stainless steel or aluminium
- Suits 5kg and 15kg spools
- Generator compatible - 13.5 kVA Peak

*For full rated output, a 32 A plug & supply is required with a 32 A circuit breaker.



WELDMATIC® 356

P/N: CP147-1

The perfect MIG choice for light to medium fabrication.

● Intermediate ● Professional

Workshops Medium to Heavy Fabrication



- 355 A three phase MIG welder
- 355 A at 31.8 V, 40% Duty Cycle
- IP21S safety rating
- Packaged with a W64-1 4 roll drive wire feeder and 10m interconnecting lead kit
- 126kg (power source, wire feeder and accessories)
- Welds 12mm+ steel/stainless steel or aluminium
- Suits 5kg and 15kg spools
- Generator compatible - 16.5 kVA Peak



WELDMATIC® 396

P/N: CP148-1

Get more power. Best for medium to heavy fabrication.

● Intermediate ● Professional

Workshops Medium to Heavy Fabrication



- 395 A three phase MIG welder
- 395 A at 33.8 V, 40% Duty Cycle
- IP21S safety rating
- Packaged with a W64-1 4 roll drive wire feeder and 10m interconnecting lead kit
- 127kg (power source, wire feeder and accessories)
- Welds 12mm+ steel/stainless steel or aluminium
- Suits 5kg and 15kg spools
- Generator compatible - 20 kVA Peak



WELDMATIC® FABRICATOR

P/N: CP149-1

The ultimate MIG Industrial Welding Solution.

● Intermediate ● Professional

Workshops Medium to Heavy Fabrication



- 400 A three phase MIG welder
- 400 A at 34 V, 45% Duty Cycle
- IP21S safety rating
- 127kg (power source, wire feeder and accessories)
- Packaged with a W64-1 4 roll drive wire feeder and 10m interconnecting lead kit
- Welds 12mm+ steel/stainless steel or aluminium
- Suits 5kg and 15kg spools
- Generator compatible - 20 kVA Peak

3 YEAR WARRANTY

PAIR IT WITH
Austfil T-11
WIA OpticFX Helmet

3 YEAR WARRANTY

PAIR IT WITH
Austmig ES6
WIA OpticFX Helmet

3 YEAR WARRANTY

PAIR IT WITH
Austmig ES6
WIA OpticFX Helmet

3 YEAR WARRANTY

PAIR IT WITH
Austmig 5356
WIA OpticFX Helmet



PLASMA CUTTERS

Ready. Set. Cut.

From the workshop to on-site WIA plasma cutters offer precise and effortless cutting.

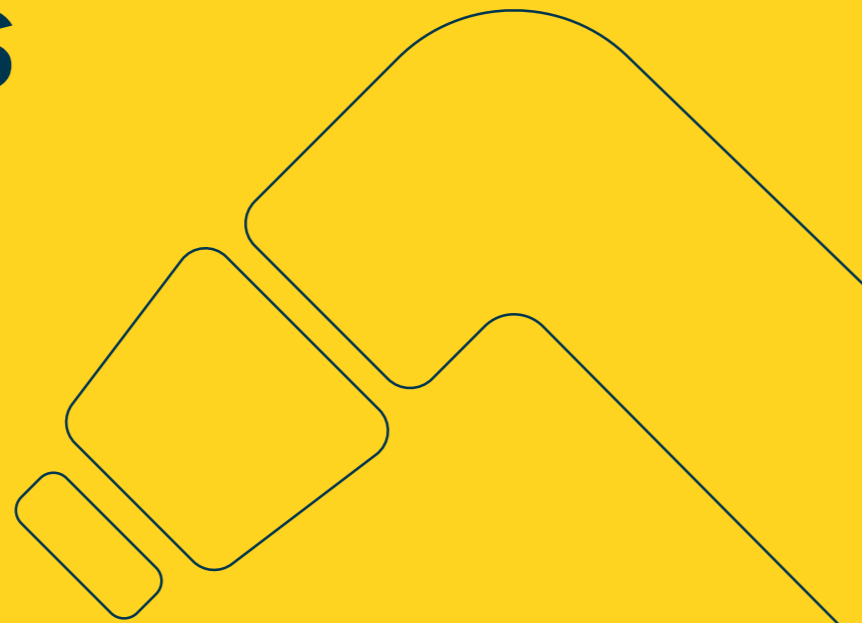

PLASMA CUTTERS



CUTMATIC® 45

P/N: MC115-0

Effortlessly clean cuts up to 16mm and sever cuts up to 20mm.

● Beginner ● Intermediate

General Fabrication On-Site Maintenance

Automotive Repair



- Clean cut 16mm
- Sever cut 20mm
- IP21S safety rating
- Cuts steel, stainless steel, aluminium copper and cast iron
- Portable - Only 11kg
- Power Factor Correction
- Plasma Torch with Pilot Arc Start (6m)
- Water and Air Filter - Removes water in the air. Increases torch tip life
- Generator compatible - 6 kVa Peak

3 YEAR WARRANTY

PAIR IT WITH
WIA OpticFX
Cutting Guide
Circle Cutting Attachment Kit

Power Factor Correction

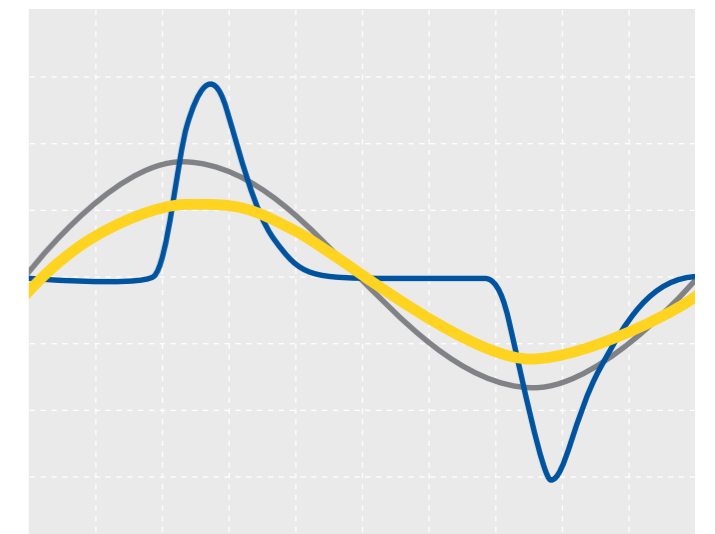

— INPUT VOLTAGE — INPUT CURRENT WITH PFC — INPUT CURRENT WITHOUT PFC

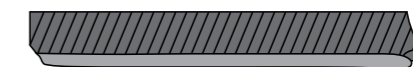

Clean Cut

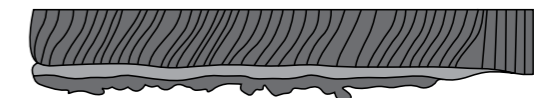

Sever Cut

Material	Clean Thickness	Sever Thickness
Steel	16	20
Stainless Steel	12	16
Aluminium	10	12



FILLER METALS

—
**High performing
& easy to use**

WIA's electrode and wire range is relied on by
Australian welders day in day out.



ELECTRODES

Nothing compares

Austarc electrodes are what professional welders rely on for the best results.

ELECTRODES



AUSTARC 16TC

P/N: 16TC25 (2.5mm), 16TC32 (3.2mm), 16TC40 (4.0mm), 16TC50 (5.0mm)

Nothing compares. This low hydrogen electrode provides the best results for all applications.

● Low Hydrogen Electrode

Agricultural Steels Structural Steel

Earth Moving Equipment

Maintenance & Repair

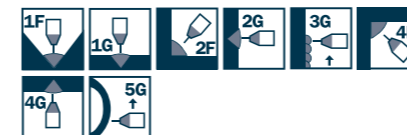

- For carbon and low alloy steels
- Exceptional arc stability
- Easy slag removal
- Low spatter
- All positional except vertical down
- Classification: AS/NZS 4855-B - E49 16-A U H10 and AWS A5.1: E7016 H8
- Manufactured in New Zealand
- Available in 2.5, 3.2, 4.0 and 5.0mm



AUSTARC 12P

P/N: 12P25 (2.5mm), 12P32 (3.2mm), 12P40 (4.0mm)

Smooth arc starting and re-striking performance for general purpose welding.

● General Purpose Electrode

Agricultural Equipment

General Machinery Wrought Iron

General Mild Steel Fabrication & Repair

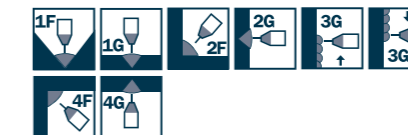

- For galvanised steels
- Fast freezing slag
- Tolerant to dirty materials
- All positional and exceptional vertical down capabilities
- Superb arc starting and re-striking on low voltage AC machines
- Classification: AS/NZS 4855-B - E43 13 A AWS A5.1: E6013
- Manufactured in New Zealand
- Available in 2.5, 3.2 and 4.0mm



AUSTARC 13S

P/N: 13S25 (2.5mm), 13S32 (3.2mm), 13S40 (4.0mm)

Ideal for down hand fillet welding of mild steel.

● General Purpose Electrode

Structural Welding

Tubular Components

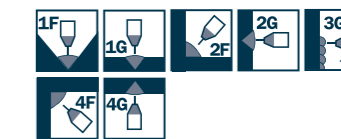

- A blue and white striped electrode for mitre fillet welding
- Provides a soft and stable arc
- Offers a self-peeling slag action
- All positional and exceptional vertical up capabilities
- Smooth performance on low OCV AC welding machines
- Classification: AS/NZS 4855-B - E43 13 A AWS A5.1: E6013
- Manufactured in New Zealand
- Available in 2.5, 3.2 and 4.0mm

MIG WIRES



MIG WIRES

High quality, repeatable performance for every job

WIA wires are the perfect match for any MIG welding machine.



AUSTMIG 5356

M535612S (1.2mm – 6kg)

Suitable for welding wrought iron or cast aluminium alloys containing magnesium.

- Solid MIG Wire – Aluminium

Cast & Wrought Aluminium Alloys Containing Magnesium



- Aluminium – 5% magnesium alloy, MIG welding wire
- Double shaved and precision layer wound for superb feed-ability
- Classification: AS/NZS ISO 18273 – S Al 5356 and AWS A5. 10: ER5356
- Available in 1.2mm



AUSTMIG ES6

P/N: EES608M5KG (0.8mm – 5kg), ES609M5KG (0.9mm – 5kg), ES609S (0.9mm – 15kg), ES610S (1.0mm – 15kg), ES612S (1.2mm – 15kg), ES616S (1.6mm – 15kg)

Provides excellent wirefeeding performance for mild and medium strength steels.

- Solid MIG Wire – Mild Steel

Mild & Medium Strength Steels



- Copper coated, low carbon steel
- All positional welding of mild and medium strength steel
- Designed for use with Argon/CO2 and CO2 shielding gases
- Excellent wire feeding and electrical conductivity
- Effective weld metal deoxidation for resistance to porosity
- Classification: AS/NZS 14341-B – G 49A 3U C/M S6 and AWS A5.1 ER70S-6
- Available in 0.8, 0.9, 1.2 and 1.6mm



AUSTFIL T-11

P/N: AUST11085KG (0.8mm – 5kg Spool), AUST11095KG (0.9mm – 5kg Spool), AUST11125KG (1.2mm – 5kg Spool)

No shielding gas required! For welding mild and galvanised steels.

- Self-Shielded Flux-Cored Wire

Mild & Galvanised Steels

Light Structures

General Fabrication



- All positional
- For single and multi-pass applications
- Full slag covering
- Easy slag removal
- Soft and smooth arc
- Shielding gas not required
- Classification: AS/NZS ISO 17632-B- T49ZT11-1NA-H15 and AWS 15.20: E71T-11
- Available in 0.8, 0.9 and 1.2mm



AUSTFIL EXCEL

P/N: AE71CM12 (1.2mm – 15kg Spool), AE71CM16 (1.6mm – 15kg Spool)

New and improved rutile type flux-cored wire designed for optimum positional welding.

- Gas Shielded Flux Cored Wire

Mild carbon and carbon - manganese steels

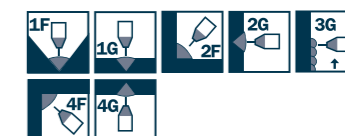

- Designed for all positional welding
- Formulated for 100% CO² and 75-80% Ar + 25-20% CO² shielding gases
- Excellent operator appeal, stable arc, low spatter, smooth bead appearance and easy slag removal
- Tested to meet Australian market requirements
- Classifications, AS/NZS ISO 17632-B: T493T1-1 M A-U-H10, T493T1-1 C A-U-H5 – AWS A5.20: E71T-1M, E71T-1C – E71T-9M, E71T-9C
- Available in 1.2 and 1.6mm



WELDING SAFETY

Protection, comfort & support

WIA welding helmets offer the protection, comfort and support every welder needs to keep safe while welding.



OPTIC FX™

P/N: Blue Knight - SH300002, Nero - SH300001

Enhanced optic clarity for a clearer more detailed view of the weld.

● Auto-Darkening Welding Helmet

Industrial Fabrication Trade DIY



- Provides a full spectrum of colours for a better view.
- Only 555g
- Viewing area 100 x 60mm
- Grind mode
- 4 arc sensors
- Switching speed - 1/12,500 sec
- Fully adjustable headgear fitted with a back cushion and an extra top band
- Meets Australian standards AS/NZS 1338.1 (Auto-Darkening) and AS/NZS 1337.1 B (High Impact)
- 3 year warranty

3 YEAR
WARRANTY

WELDING HELMETS

See the difference

For MIG, Stick, TIG and plasma cutting, you'll be able to see more and weld better with WIA Helmets.

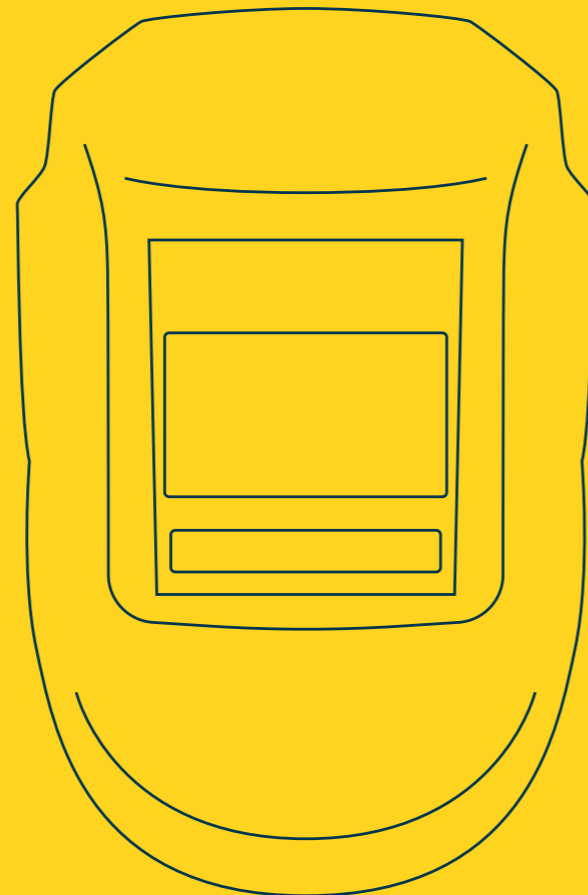

STAY CONNECTED WITH WIA

We take pride in providing our customers with the welding information they need. If you're after product details or specifications, news stories or handy welding tips, you'll be able to find it all on our website.

Want to be the first to know about new releases and promotions before anyone else?

Follow us on social media to stay in the loop.

> welding.com.au

 [/wia.welding](https://www.facebook.com/wia.welding)

 [@wia.welding](https://www.instagram.com/wia.welding)

 [/company/wia-welding-industries-australia-](https://www.linkedin.com/company/wia-welding-industries-australia-)

 [@wia-welding](https://www.youtube.com/@wia-welding)





WIA

Distributed by:

Issue date: December 2022

WELDING.COM.AU

**WELDING
INDUSTRIES
AUSTRALIA**

WIA

